

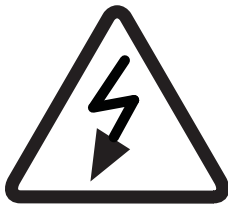

## HAZARD CATAGORIES AND SPECIAL SYMBOL

Read all instruction carefully and check the device before installing or service it. The following safety alert symbol may appear throughout this manual or on device to warn any potential hazards or to call for attention.



### **PLEASE NOTE**

The power meter should be installed, operated, serviced and maintained only by qualified personnel. No responsibility is assumed by the manufacturer for any consequences arising out of the use of this material.

### **DISCLAIMER**

Mikro shall not be liable for errors contained herein including any incidental and/or consequential damages arising from the use of this material. Mikro also reserves the right to vary the product from that described in this material without prior notice.

### **COPYRIGHT**

The licensed software contained in the product is proprietary software owned by Mikro or its third party suppliers and shall be used solely in connection with the product.

## BEFORE YOU BEGIN

- Apply appropriate personal protective equipment and follow safe electrical work practices.
- NEVER work alone.
- Turn-off all power supplying the power meter and the equipment in which it is installed before working on it.
- Always use a properly rated voltage sensing device to confirm that all power is off.
- Before closing all covers and doors, carefully inspect the work area for tools and objects that may have been left inside the equipment.
- NEVER bypass external fusing.
- NEVER open circuit a CT; use the shorting block to short circuit the leads of the CT before removing the connection from the power meter.
- Before performing hi-pot testing on any equipment in which the power meter is installed, disconnect all input and output wires to the power meter. High voltage testing may damage electronic components contained in the power meter.
- The power meter should be installed in a suitable electrical enclosure.

**Failure to follow this instruction may result in serious injury.**

# CONTENTS

<b>1. Introduction</b>	<b>1</b>
1.1.Content of box	1
1.2.Part of power meter	2
<b>2. Installation Guide</b>	<b>4</b>
2.1.Precautions	4
2.2.Mounting	4
2.3. Wiring	7
<b>3. Meter parameters</b>	<b>11</b>
<b>4. Display and Buttons</b>	<b>12</b>
<b>5. Function</b>	<b>13</b>
<b>6. Setting up</b>	<b>15</b>
6.1.Access programming mode	15
6.2.Setup CT ratio	16
6.3.Setup PT ratio	17
6.4.Neutral current	18
6.5.Setup communication configuration	19
6.6.Demand setting	20
6.7.System setting	21
6.8. Reset all energy register	22
6.9. Reset demand register	23
6.10. Reset maximum & minimum value	24
6.11. Remote set	25
6.12. Scroll mode setting	26

6.13. Scroll delay setting	27
6.14. Reset Hour on register	28
6.15. Backlight setting	29
6.16. Exit from programming mode	30
6.17. Setup new password	31
<b>7. Specifications</b>	<b>33</b>
<b>8. Modbus table</b>	<b>36</b>
<b>9. Maintenance and troubleshooting</b>	<b>50</b>
<b>10. Dimensions</b>	<b>51</b>
<b>11. Appendix</b>	<b>53</b>
11.1. Demand calculation	53
11.2. Data read format from modbus	54

## FIGURES

1. Parts of power meter	2
2. Recommendation cut-out	4
3. 3-phase 4-wire system with 4 CTs	7
4. 3-phase 4-wire system with 3 CTs	8
5. 3-phase 3-wire with 3CTs and 3VTs	9
6. 3-phase 3-wire with 2CTs and 3VTs	10
7. Menu map for the normal mode	13
8. Flow map for the programming mode	14

## TABLE

1. Parts list	1
2. Location and part label	2
3. Model information	3
4. Specification	33
5. Data length nomenclature	36
6. Device and communication register	37
7. Operation data registers	37
8. Setting data registers	49

# 1.Introduction

Thank you for purchasing the DPM380 Digital Power Meter. This multifunction power meter measuring the following parameters:

- True RMS phase voltage ( L-N )
- True RMS line voltage (L-L )
- True RMS phase and neutral current
- Active, reactive and apparent power
- Total active, reactive and apparent energy
- Total and displacement power factor
- Frequency
- Voltage and current total harmonic distortion (THD)
- Demand and maximum demand for total active, reactive and apparent power
- Maximum and minimum phase and line voltage
- Maximum and minimum phase and neutral current
- Maximum and minimum total active, reactive and apparent power

## 1.2. CONTENT OF BOX

Upon opening this box, you should find the following item shown in table 1:

No	Description	Quantity
1	DPM380 power meter	1
2	Retainer clip	2
3	Quick guide	1

Table 1 : Parts list

### 1.3. PARTS OF POWER METER

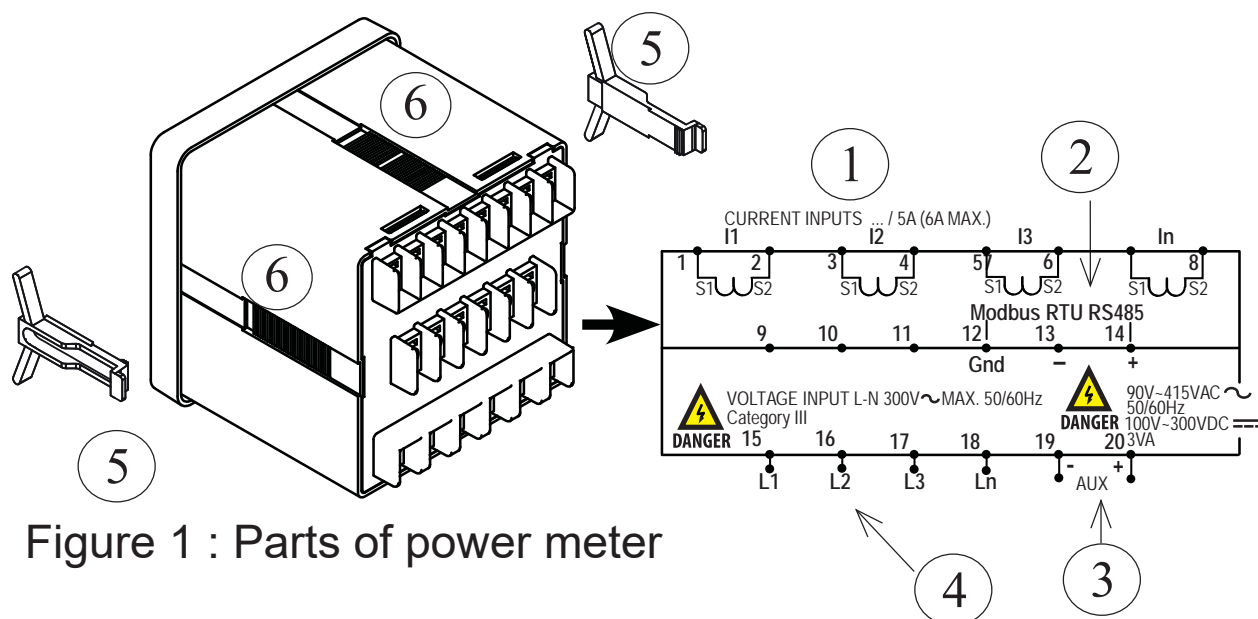

Figure 1 : Parts of power meter

Table 2: Location and part label

Number	Part	Description
1	Current inputs	Current metering connections.
2	RS485 port	The RS485 port is used for communication with remote monitoring and control system.
3	Power supply input	Connection to power the meter
4	Voltage inputs	Voltage metering connections.
5	Retainer clips	Used to hold power meter in place.
6	Retainer clips slot	To slot in retainer clips in place



<b>Model Information</b>	
DPM380-415AD	Auxiliary 90~415VAC or 100~300VDC; with Modbus

Table 3: Model information

## 2. Installation Guide

### 2.1. PRECAUTIONS



Before installing the power meter, please check that the environment meets the following condition:

- Operating temperature -10 Celcius to +55 Celcius.
- Humidity 5% to 95%, non-condensing
- Dust free environmental away from electrical noise and radiation

### 2.2. MOUNTING

a) Provide a cut out hole on the switchgear panel according to the dimension below.

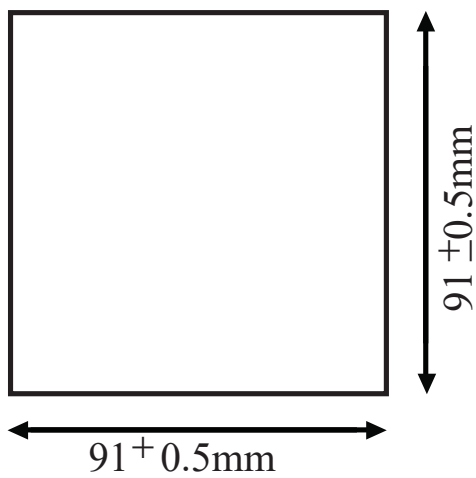

Figure 2: Recommended out-cut.

b) Insert the power meter through the hole and slide in the retainer clip along the slots on left and right sides or bottom and top sides of the power meter until the device is tightly secured on the switchgear panel. The orientation of the retainer clips is shown in figure 1.

The retainer clip can be removed by lifting the tab lightly at the handle end.

c) Connect the metering voltage input, current input, communication and auxiliary according to the wiring schemes shown in section 2.2 figure 3 to 6 on the next page.

d) The recommended wire size is as below:

- voltage input and auxiliary - AWG16~22
- current input - AWG12~18
- Modbus-RTU - AWG22 or thicker, shielded twisted pair



**NOTE:** Polarity marks must be followed as shown for CTs (S1 and S2).

Please make sure the power to the current metering input is totally shunted. Under no circumstances can the CT connection be left open circuit. Use a CT shorting block if necessary.

e) When connecting the power meter, please make sure the polarity to the terminal is correctly aligned.

f) If the Modbus-RTU is used, it can be connected up to 32 devices in a daisy chain fashion and the cable total length should not be more than 1000m.



**NOTE:** For Modbus-RTU connection, avoid running the cable near sources of electrical noise. The network cable shield should be grounded at only one end.

## 2.3. WIRING

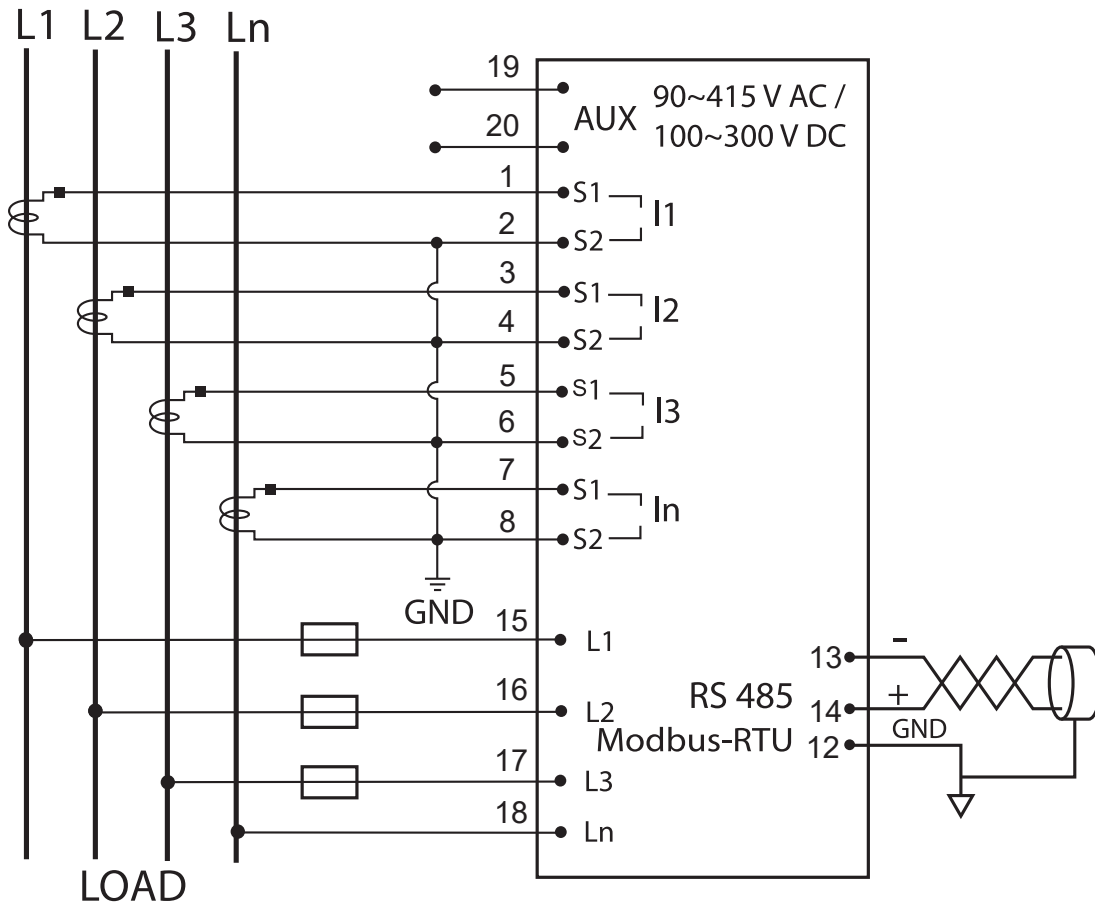

Figure 3: 3 Phase 4-Wire System with 4CTs connection, direct voltage input.

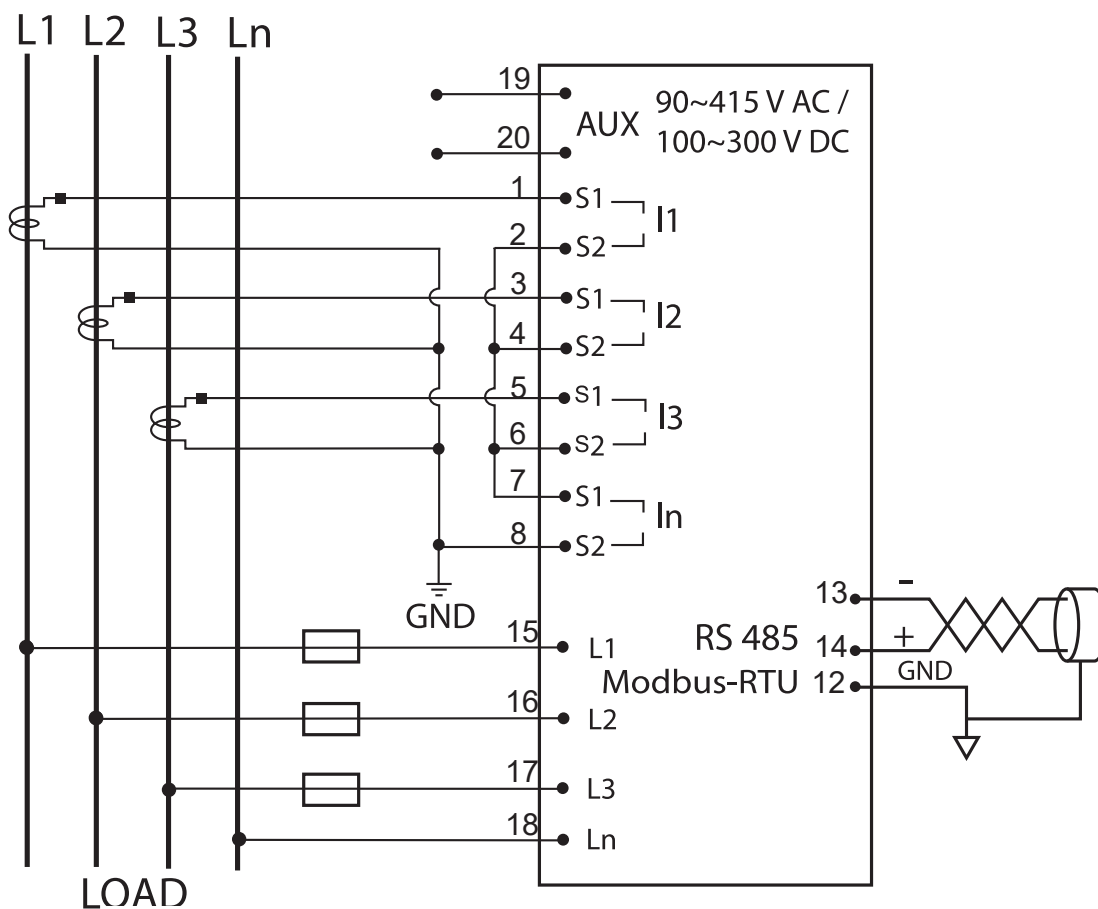

Figure 4: 3-Phase 4-Wire System with 3CTs connection, direct voltage input.

**NOTE:** Neutral current measurement is based on the vector sum of 3 CTs.

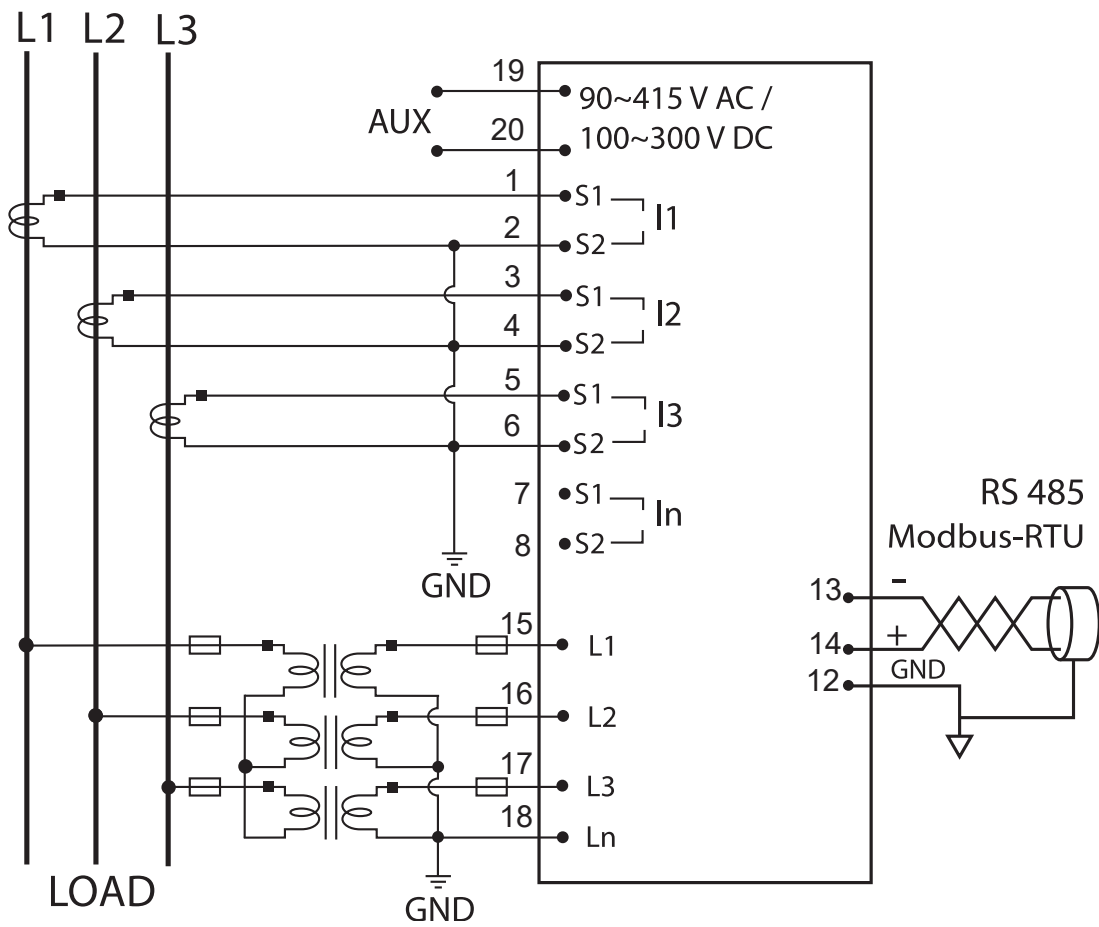

Figure 5: 3-phase 3-wire with 3CTs and 3VTs connection.

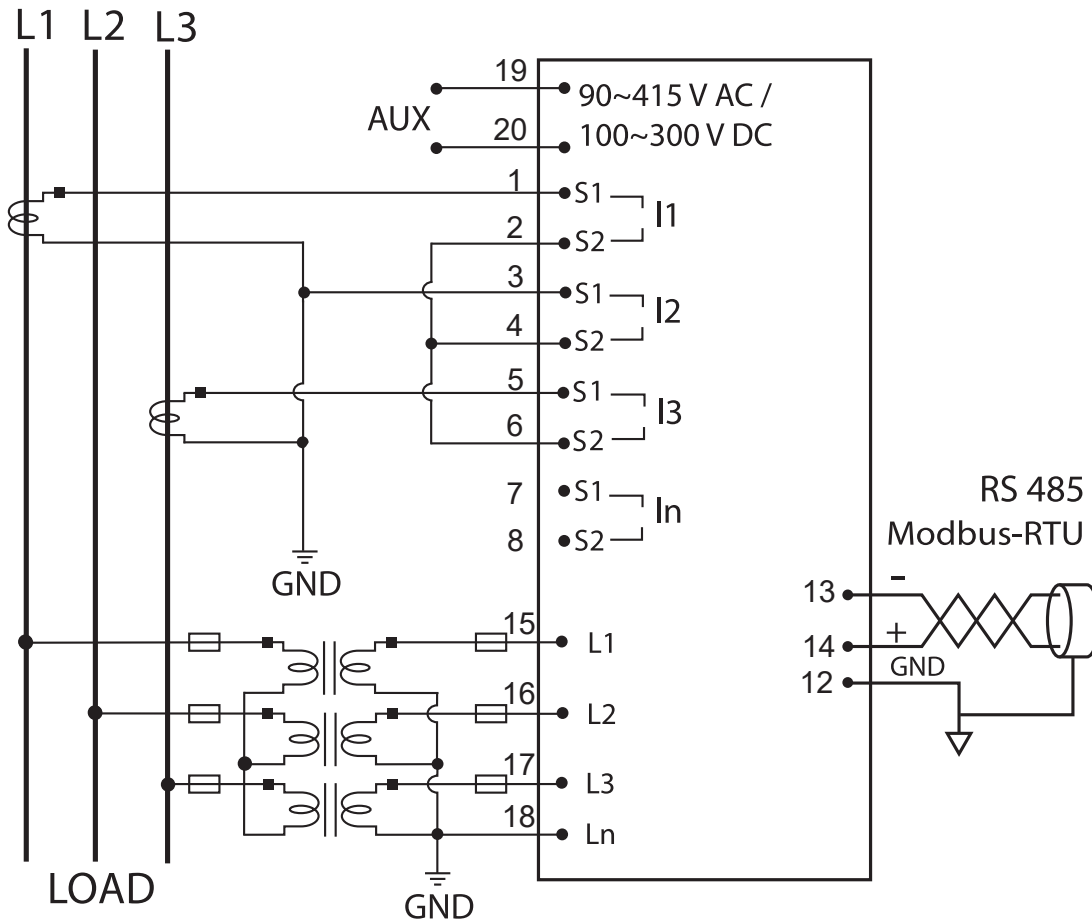

Figure 6: 3-phase 3-wire with 2CTs and 3VTs connection.

**NOTE:** I2 current measurement is based on the vector sum of 2 CTs.



### ***3. Meter parameters***

Before commencing operation, the meter has to be set up. To do this, the meter must be powered up by the meter control power supply.

Under section 6, the following parameters should be reviewed against the default value if necessary:

- CT ratio
- PT ratio
- Neutral current input
- Modbus-RTU setting
- Demand setting
- System setting
- Scroll mode setting and delay time
- Backlight setting

The flow maps for the meter is under section 5. It is guideline for the user to flip to the desire window whether in normal mode or programming mode.

## 4. Display and Buttons

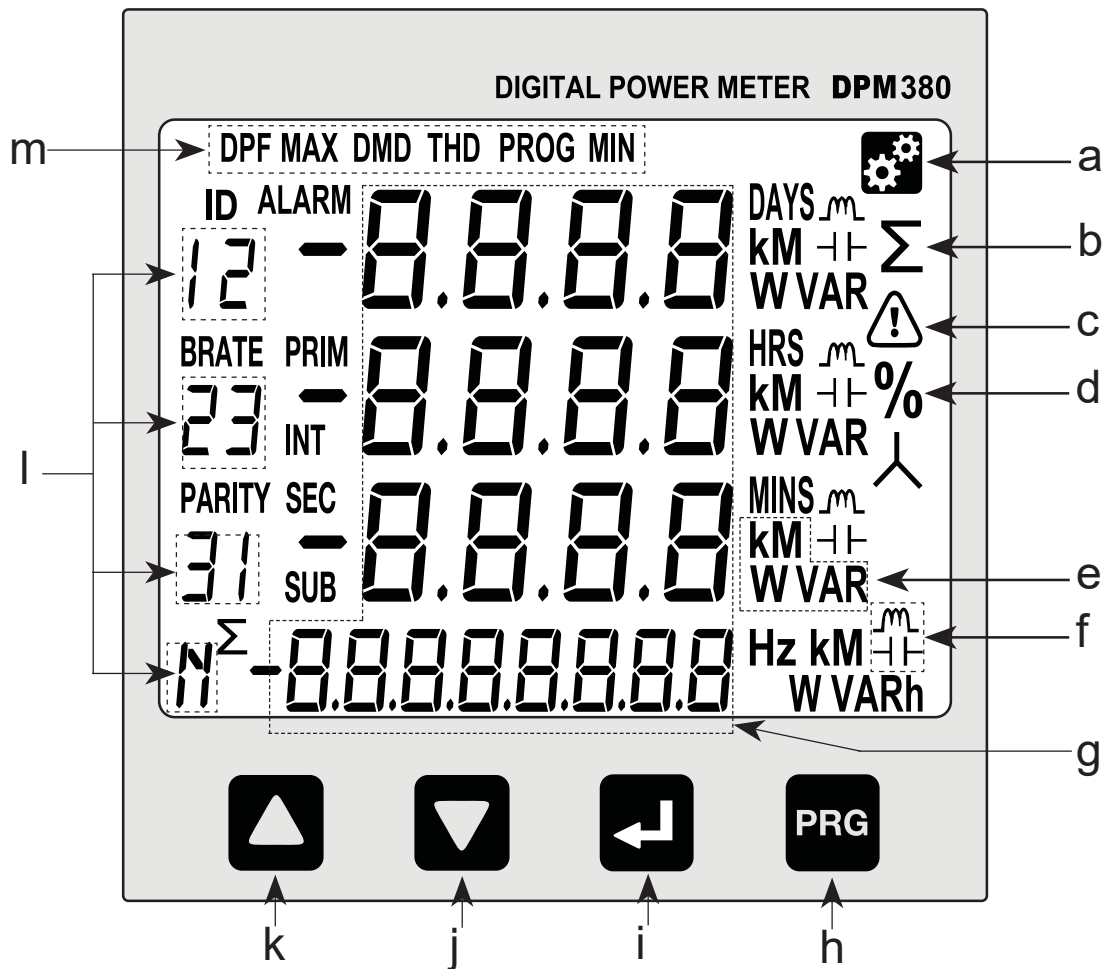

- a. Setting Indicator
- b. Total Indicator
- c. Alarm Indicator
- d. Percentage Indicator
- e. Unit Indicator
- f. Capacitive/Inductive Indicator
- g. Digit Display
- h. 'PROG' button
- i. 'NEXT' button
- j. 'DOWN' button
- k. 'UP' button
- l. Phase Indicator
- m. Window Indicator

## 5. Function

Figure 7 below shows menu map for the power meter. It includes the setting and measurement display for the power meter. These menus can be accessed by pressing NEXT, UP, PROG & DOWN buttons.



Figure 7 : Menu map for normal mode.

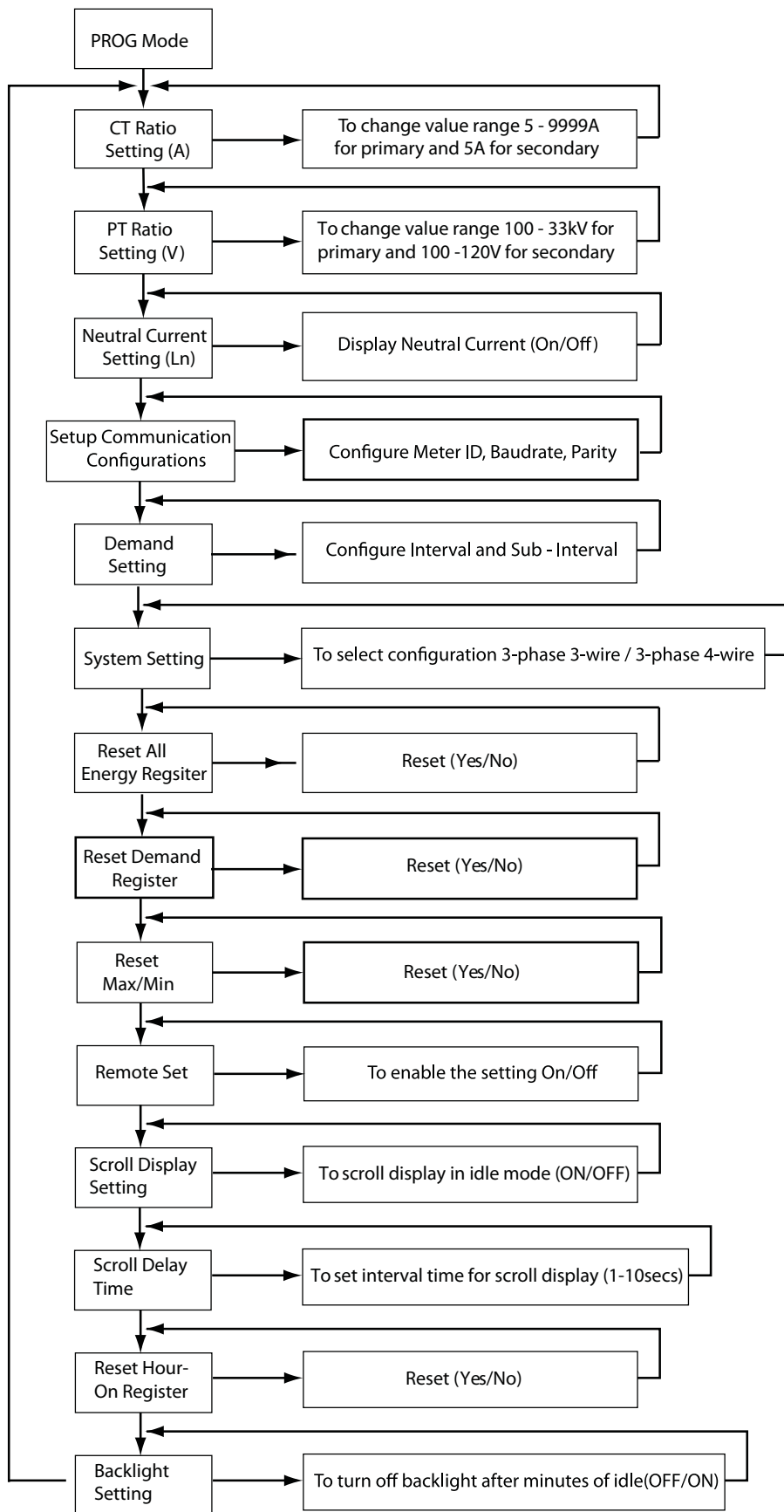
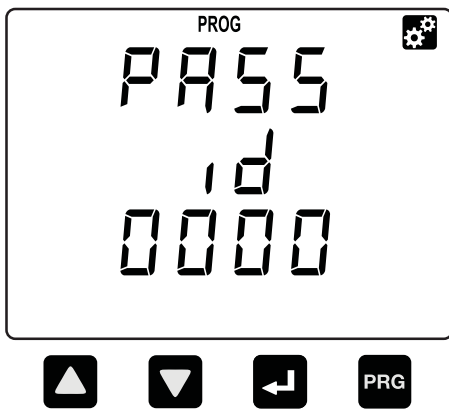

Figure 8 : Menu map for programming mode

## 6. Setting up

The power meter comes with factory default settings. These values may be changed by navigating to the appropriate screens and entering new values. Use the instructions in the following sections to change the values.

### 6.1. ACCESS PROGRAMMING MODE



- Press the PROG button to enter programming mode. The first number will blink to enter password.
- Use the UP or DOWN button to change display value and the NEXT button to shift to next number.
- Press the PROG button to confirm and enter programming mode. Setup CT ratio will be display. If the password is incorrect, the meter will return to normal mode.
- To exit press the PROG button and display will return to normal mode.

**NOTE:** Default password is “0000”

## 6.2. SETUP CT RATIO

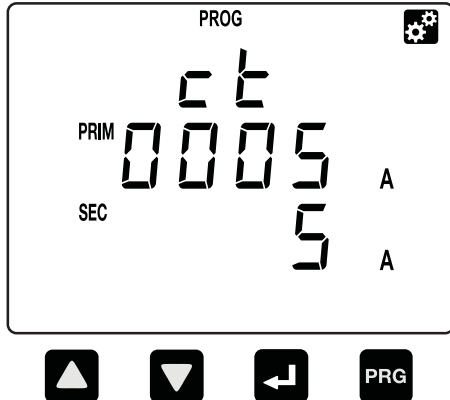

- a. CT ratio setting is the first item display in programming mode.
- b. Press the NEXT button to change. The first digit will blink.
- c. Use the UP or DOWN button to change the primary CT value.
- d. Press the NEXT button for the next digit. Repeat step (b) & (c) to change, or else press NEXT button till the digit stop blinking.
- e. To proceed next setting press DOWN button. To exit programming mode, press the PROG button. The user will be prompted to confirm the saving of settings if change is made. Refer section 6.16.

**NOTE:** CT ratio default value is 5/5A

### 6.3. SETUP PT RATIO

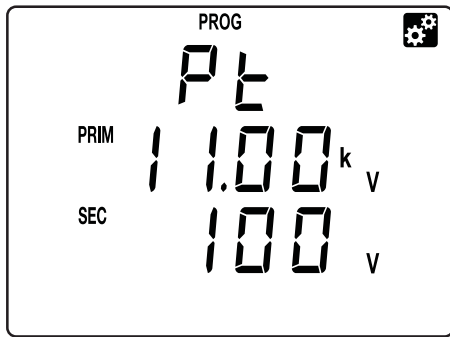

- a. Scroll in programming mode until "Pt" is displayed using the UP or DOWN button.
- b. This parameter is to change the PT value if the Power Transformer (PT) is connected.
- c. Press the NEXT button to change. The "V" symbol for primary will blink.
- d. Press the UP or DOWN button to change the value of setting.
- e. Press the NEXT button to confirm the new setting and proceed for secondary setting.
- f. Repeat step (c) & (d) to change for secondary. Once confirm, press the NEXT button again to confirm. The secondary "V" will stop blinking.
- g. To exit programming mode, press the PROG button. Refer section 6.16.

**NOTE:** PT ratio default value is 100/100V

## 6.4. NEUTRAL CURRENT

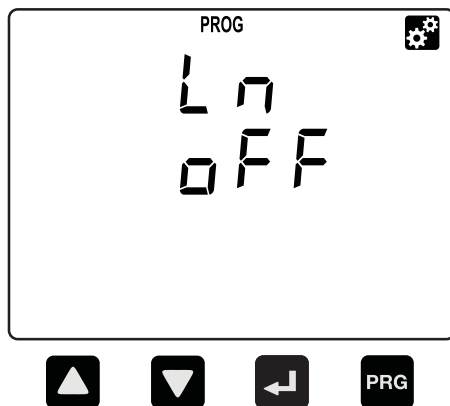

- a. Scroll in programming mode until "Ln" is displayed using the UP or DOWN button.
- b. This parameter is to display neutral current if the neutral current (Ln) is connected.
- c. Press the NEXT button to change. The "PROG" symbol will blink.
- d. Press the UP or DOWN button to toggle the symbol "ON" for enable or "OFF" for disable.
- e. Press the NEXT button to confirm the new setting.
- f. To proceed to the next setting, press the DOWN button.
- g. To exit programming mode, press the PROG button. The user will be prompted to confirm the saving of settings if change is made. Refer section 6.16.

**NOTE:** Neutral current default value is ON



## 6.5. SETUP COMMUNICATION CONFIGURATIONS

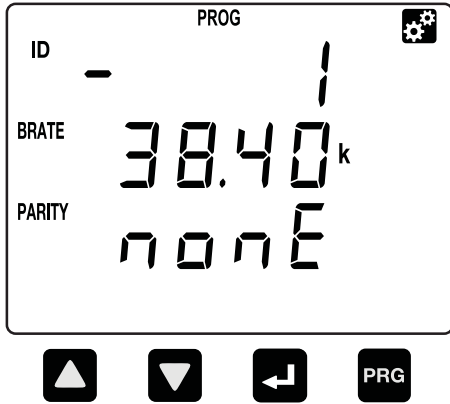

- a. Scroll until "ID BRATE PARITY" is displayed using the UP or DOWN button.
- b. Press the NEXT button. The "PROG" and "-" symbol next to "ID" will blink. Use the UP or DOWN button to change the device ID.
- c. Next, press the NEXT button and "-" symbol next to "BRATE" will blink to change baudrate. Repeat step (b) to change.
- d. Press NEXT button to change parity and "-" symbol next to "PARITY" will blink. Repeat step (b) to change.
- e. Then press the NEXT button to confirm new setting. The "PROG" will stop blinking.
- f. To proceed next setting press DOWN button. To exit programming mode, press the PROG button. The user will be prompted to confirm the saving of settings if change is made. Refer section 6.16.

**NOTE:** Default value for the communication ID is 0001, baudrate is 38400 bps and parity set to none.

## 6.6. DEMAND SETTING

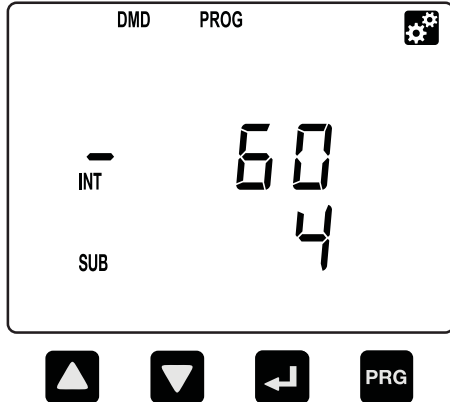

- a. Scroll until "DMD" is displayed using the UP or DOWN button.
- b. Press the NEXT button to change interval value. The "PROG" symbol will displayed and "-"symbol next to "INT" will blink.
- c. Use UP or DOWN button to change value and press NEXT button to confirm and change sub-interval setting. The "-" symbol next to "SUB" will blink. Press UP or DOWN button to change and NEXT button to confirm.
- d. To proceed next setting press DOWN button. To exit programming mode, press the PROG button. The user will be prompted to confirm the saving of settings if change is made. Refer section 6.16.

**NOTE:** Demand setting default value is 60/4

## 6.7. SYSTEM SETTING

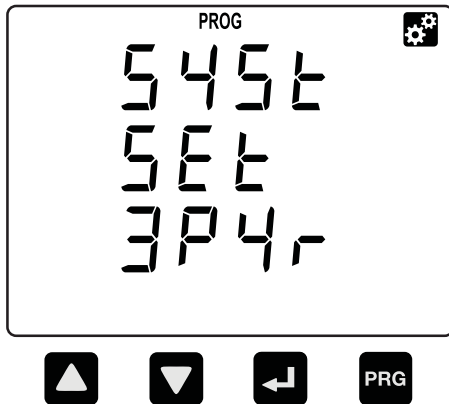

- a. Scroll in programming mode until "SYSt sEt" is displayed using the UP or the DOWN button.
- b. Press the NEXT button. The "PROG" symbol will blink. Use the UP or DOWN button to toggle 3-phase 4-wire "3P4r" or 3-phase 3-wire "3P3r" symbols.
- c. Press the NEXT button to confirm new setting.
- d. To proceed next setting press DOWN button. To exit programming mode, press the PROG button. The user will be prompted to confirm the saving of settings if change is made. Refer section 6.16.

**NOTE:** System setting default value is 3-phase 4-wire

## 6.8. RESET ALL ENERGY REGISTER

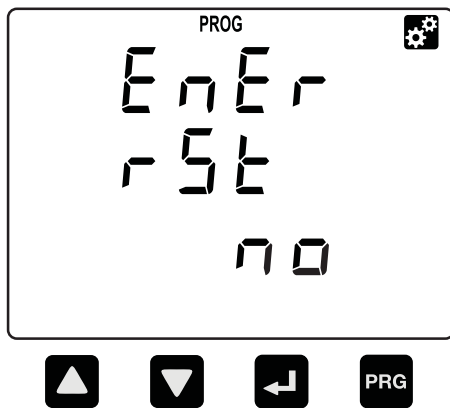

- a. Scroll in programming mode until "EnEr rSEt" is displayed using the UP or the DOWN button.
- b. Press the NEXT button. The "PROG" symbol will blink. Use the UP or DOWN button to toggle "YES" or "NO" symbols.
- c. To abort clearing energy register values, select "NO". To clear all energy values select "YES".
- d. Press the NEXT button to confirm the new setting.
- e. To proceed next setting press DOWN button.
- f. To exit programming mode, press the PROG button. The user will be prompted to confirm the saving of settings if change is made. Refer section 6.16.

## 6.9. RESET DEMAND REGISTER

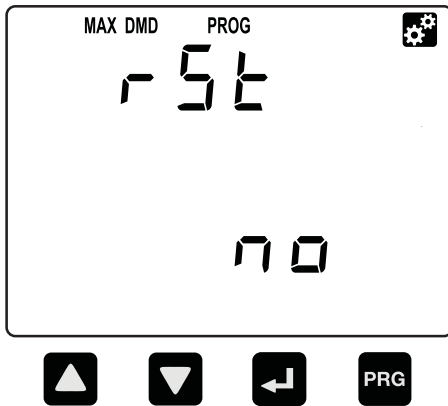

- a. Scroll in programming mode until "dMd rSt" is displayed using the UP or the DOWN button.
- b. Press the NEXT button. The "PROG" symbol will blink. Use the UP or DOWN button to toggle "YES" or "NO" symbols.
- c. To abort clearing demand register, select "NO". To clear all demand register select "YES".
- d. Press the NEXT button to confirm the new setting.
- e. To proceed next setting, press DOWN button.
- f. To exit programming mode, press the PROG button. The user will be prompted to confirm the saving of settings if change is made. Refer section 6.16.

## 6.10. RESET MAXIMUM AND MINIMUM VALUE



- a. Scroll until "rSEt" is displayed using the UP or the DOWN button.
- b. Press the NEXT button. The "PROG" symbol will blink. Use the UP or DOWN button to toggle "YES" or "NO" symbols.
- c. To abort clearing max. and min. values, select "NO". To clear all max. and min. values select "YES".
- d. Press the NEXT button to confirm new setting.
- e. To proceed next setting press DOWN button. To exit programming mode, press the PROG button. The user will be prompted to confirm the saving of settings if change is made. Refer section 6.16.

## 6.11. REMOTE SET

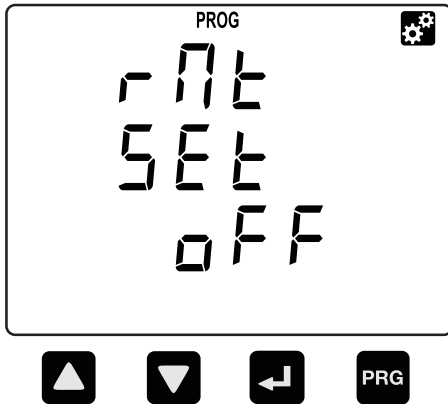

- a. Scroll until "rMt SEt" is displayed using the UP or the DOWN button.
- b. Press the NEXT button. The "PROG" symbol will blink. Use the UP or DOWN button to toggle Enable "ON" or disable "OFF" symbols.
- c. Press the NEXT button to confirm new setting.
- d. To proceed next setting press DOWN button. To exit programming mode, press the PROG button. The user will be prompted to confirm the saving of settings if change is made. Refer section 6.16.

**NOTE:** Enabling the remote set allows the remote terminal to read and write the meter setting via Modbus-RTU, otherwise the setting data can only be read. Default value is ON.

## 6.12. SCROLL SETTING

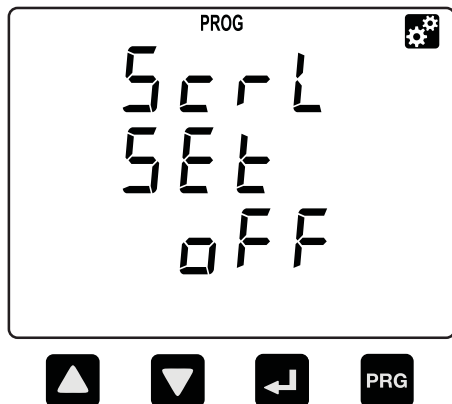

- a. Scroll in programming mode until "Scrl SET" is displayed using the UP or the DOWN button.
- b. This function is to turn ON/OFF scroll mode. If turn on, when the display is idle the meter will shows each window in normal mode base on the scroll delay setting time.
- c. Press the NEXT button. The "PROG" symbol will blink. Use the UP or DOWN button to toggle "OFF" or "ON" symbols.
- d. Press the NEXT button to confirm the new setting.
- e. To proceed next setting, press DOWN button.
- f. To exit programming mode, press the PROG button. The user will be prompted to confirm the saving of settings if change is made. Refer section 6.16.

**NOTE:** Scroll setting default value is OFF



## 6.13. SCROLL DELAY SETTING



- a. Scroll in programming mode until "Scrl dELY" is displayed using the UP or the DOWN button.
- b. This function is to set time interval for scroll window.
- c. Press the NEXT button. The "PROG" symbol will blink. Use the UP or DOWN button to set 1sec to 10secs interval.
- d. Press the NEXT button to confirm the new setting.
- e. To proceed next setting, press DOWN button.
- f. To exit programming mode, press the PROG button. The user will be prompted to confirm the saving of settings if change is made. Refer section 6.16.

**NOTE:** Scroll delay time default value is 10 seconds.

## 6.14. RESET HOUR-ON REGISTER

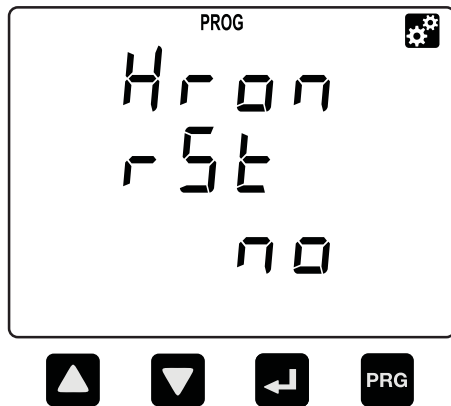

- a. Scroll in programming mode until "Hron rSt" is displayed using the UP or the DOWN button.
- b. This function is to clear hour-on register.
- c. Press the NEXT button. The "PROG" symbol will blink. Use the UP or DOWN button to toggle "YES" or "NO" symbols.
- d. To abort clearing hour-on register, select "NO". To clear hour-on register select "YES".
- e. Press the NEXT button to confirm the new setting.
- f. To proceed next setting, press DOWN button.
- g. To exit programming mode, press the PROG button. The user will be prompted to confirm the saving of settings if change is made. Refer section 6.16.

## 6.15. BACKLIGHT SETTING

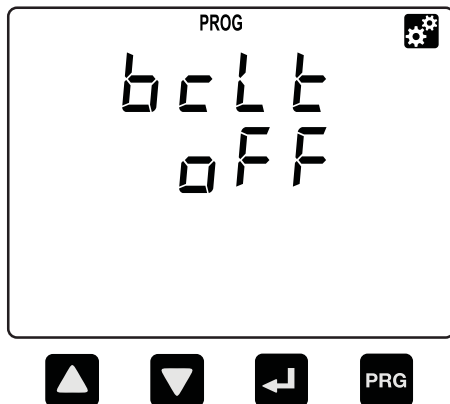

- a. Scroll in programming mode until "bcLt" is displayed using the UP or the DOWN button.
- b. This function is to turn off backlight after 10minutes idle.
- c. Press the NEXT button. The "PROG" symbol will blink. Use the UP or DOWN button to toggle "OFF" or "ON" symbols.
- d. Press the NEXT button to confirm the new setting.
- e. To proceed next setting, press DOWN button.
- f. To exit programming mode, press the PROG button. The user will be prompted to confirm the saving of settings if change is made. Refer section 6.16.

**NOTE:** Backlight setting default value is OFF

## 6.16. EXIT FROM PROGRAMMING MODE

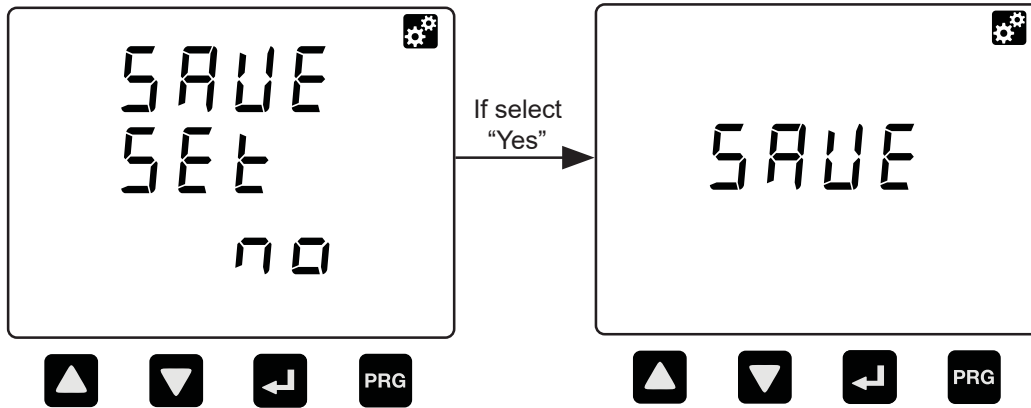

- a. Use the PROG button exit from programming mode window. Any changes made in the setting will be prompted to confirm saving. The “SAVE SET” display will appear.
- b. Use the UP or DOWN button to select “YES” or “NO” symbols.
- c. To exit without saving the new value, select “NO” or else select “YES”. To confirm, press PROG button.
- d. If select “YES”, the window display “SAVE” for few seconds to save new setting.
- e. Then, meter will exit from programing mode to normal mode.

## 6.17. SETUP THE PASSWORD

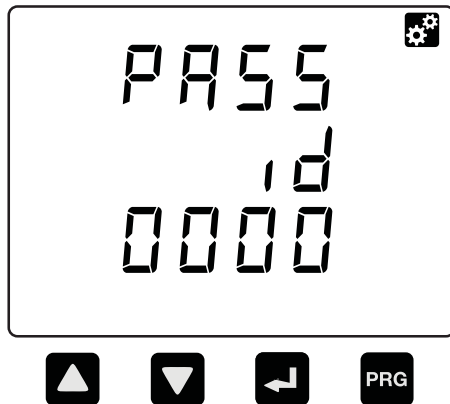

- a. Press the NEXT and PROG buttons simultaneously until the password ID request window is displayed. Key in the current password. Refer to section 6.1 on how to do this.



- b. After pressing the PROG button, the “new id” window will be displayed. At this stage, the user needs to key in the new password. Use the UP or DOWN button to change the digit value and the NEXT button to shift to next digit. Once confirmed, press the PROG button.

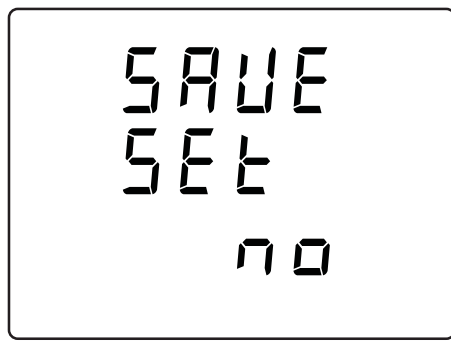

- c. Next, the “SAVE SET” will be displayed. Use the UP or DOWN buttons to toggle the “YES” and “NO” symbols to save the new password. Once confirmed, press the PROG button and the meter will return to normal display mode.

## 7. Specification

Electrical Characteristic	
System	3P3W & 3P4W
Current	
Display	Three phase current & neutral(selectable)
CT Primary	5-9995A
CT Secondary	5A
Accuracy	0.5% (from 1A to 6A secondary)
Sustained overload	6A
Voltage measurement	
PT Primary	100-33kV
PT Secondary	100-250V, no PT
Secondary Phase Voltage	20~300VAC
Accuracy	0.5%
Power (kW,kVAR,kVA) measurement	
Display	each phase & total
Accuracy	1%
Power factor measurement	
Display	each phase & total
Accuracy	1%

Table 4 : Specification

Table 4: Specification (cont)

Frequency measurement	
Range	45~65Hz
Accuracy	0.5%
Energy measurement	
Active	IEC62053-21:Class 1
Reactive	IEC62053-23:Class 2
Demand measurement	
Demand interval	60 to 1800 seconds
Demand sub-interval	1 to 120
Communication	
Hardware Interface	Isolated RS485
Protocol	Modbus-RTU
ID	1 to 255
Baudrate	2400, 4800, 9600, 19200, 38400
Parity	None, even, odd
Operating Condition	
Auxiliary Supply	90~415VAC or 100~300VDC
Operating Temperature	-10 C ~ +55 C
Storage Temperature	-20 C ~ +70 C
Operating time (on hour)	Up to 9999 days, 23 hours, 59 minutes.



Table 4: Specification (cont)

Mechanical Characteristic	
Dimension	
Case	L96mm x W96mm x H105mm
Mounting type	Panel
LCD view area	76mmx56.5mm
Weight	480g
Electromagnetic Compatibility (EMC)	
Part 6-2: Generic Standards IEC61000-6-2	Immunity for industrial environments
Part 6-4: Generic Standards IEC61000-6-4	Emission standard for industrial environments

## 8. Modbus Data Register

### 8.1 Data Type

By default, the data format in each register is unsigned 16-bit word. Shorter data may be encoded in the unsigned 8-bit byte format whereas longer data may be encoded either in the unsigned 32-bit double word format, signed 32-bit integer format or signed 64-bit long integer format. Two's complement is used to represent signed numbers. The nomenclature used in this manual is shown in Table 5.

Data Length	Unsigned	Signed
4-bit	nibble	-
8-bit	byte	-
16-bit	word	short
32-bit	dword	int
64-bit	qword	long

Table 5: Data length nomenclature

For data with length shorter than 16 bits, the upper unused bits, nibbles or bytes can be ignored. In cases where multiple registers are required, the big endian convention shall apply unless otherwise specified.

### 8.2 List Register

Tables 6 and 7 show the read only variables (function code 0x03 or 0x04) for device & communication info, operations, power factor and harmonics data respectively whereas Table 8 shows the read and write variables (function codes 0x03, 0x04 or 0x06) for the settings data.

Table 6: Device and communication register

Read Only (Function 0x03 or 0x04)		
0-1	Reserved	
2-3	Device Type	
4-5	Version	
Read Only (Function 0x03 or 0x04)		
1000	Device ID	1-255
1001	Parity	1=none 2=even 3=odd
1002	Baudrate	1=2400 2=4800 3=9600 4=19200 5=38400

Table 7: Operation data registers

Read Only (Function 0x03 or 0x04)				
Register	Description	Type	Min. Unit	Range
4000-4001	Negative Real Energy	dword	1kWh	0~1000000M
4002-4003	Positive Real Energy	dword	1kWh	0~1000000M
4004-4005	Reserved			
4006-4007	Apparent Energy	dword	1kVAh	0~1000000M

Table 7: Operation data register (cont)

Read Only (Function 0x03 or 0x04)				
Register	Description	Type	Min. Unit	Range
4008-4009	Negative Reactive Energy	dword	1kVArh	0~1000000M
4010-4011	Positive Reactive Energy	dword	1kVArh	0~1000000M
4012-4013	Total Real Power	int	1W	-2000M~2000M
4014-4015	Total Apparent Power	dword	1VA	0~2000M
4016-4017	Total Reactive Power	int	1VAR	-2000M~2000M
4018	Total Power Factor	word	0.001	0 ~ 1.000
4019	Frequency	word	0.01Hz	45.00 ~ 65.00
4020-4021	Instantaneous Current L1	dword	0.001A	0~999.9kA
4022-4023	Instantaneous Current L2	dword	0.001A	0~999.9kA
4024-4025	Instantaneous Current L3	dword	0.001A	0~999.9kA
4026-4027	Instantaneous Current Ln	dword	0.001A	0~999.9kA
4028-4029	Voltage Phase L12	dword	0.1V	0~999.9kV
4030-4031	Voltage Phase L23	dword	0.1V	0~999.9kV

Table 7: Operation data register (cont)

Read Only (Function 0x03 or 0x04)				
Register	Description	Type	Min. Unit	Range
4032-4033	Voltage Phase L31	dword	0.1V	0~999.9kV
4034-4035	Voltage Phase L1	dword	0.1V	0~999.9kV
4036-4037	Voltage Phase L2	dword	0.1V	0~999.9kV
4038-4039	Voltage Phase L3	dword	0.1V	0~999.9kV
4040-4041	Real Power L1	int	1W	-2000M~2000M
4042-4043	Real Power L2	int	1W	-2000M~2000M
4044-4045	Real Power L3	int	1W	-2000M~2000M
4046-4047	Apparent Power L1	dword	1VA	0 ~999.9M
4048-4049	Apparent Power L2	dword	1VA	0~999.9M
4050-4051	Apparent Power L3	dword	1VA	0~999.9M
4052-4053	Reactive Power L1	int	1VAR	-2000M~2000M
4054-4055	Reactive Power L2	int	1VAR	-2000M~2000M
4056-4057	Reactive Power L3	int	1VAR	-2000M~2000M

Table 7: Operation data register (cont)

Read Only (Function 0x03 or 0x04)				
Register	Description	Type	Min. Unit	Range
4058-4059	Total Demand Reactive Power	int	1VAR	-2000M~2000M
4060-4061	Max.Total Demand Reactive Power	int	1VAR	-2000M~2000M
4062-4063	Reserved			
4064-4065	Total Demand Real Power	int	1W	-2000M~2000M
4066-4067	Max. Total Demand Real Power	int	1W	-2000M~2000M
4068-4069	Reserved			
4070-4071	Total Demand Apparent Power	dword	1VA	0~2000M
4072-4073	Max. Total Demand Apparent Power	dword	1VA	0~2000M
4074-4075	Reserved			
4076	Displacement Power Factor L1	word	0.001	0 ~ 1.000
4077	Displacement PF sign L1	word	-	0=Resistive; 1=ind; 2=cap
4078	Displacement Power Factor L2	word	0.001	0 ~ 1.000
4079	Displacement PF sign L2	word	-	0=Resistive; 1=ind; 2=cap

Table 7: Operation data register (cont)

Read Only (Function 0x03 or 0x04)				
Register	Description	Type	Min. Unit	Range
4080	Displacement Power Factor L3	word	0.001	0 ~ 1.000
4081	Displacement PF sign L3	word	-	0=Resistive; 1=ind; 2=cap
4082	THD Current L1	word	0.1%	0 ~ 1000
4083	THD Current L2	word	0.1%	0 ~ 1000
4084	THD Current L3	word	0.1%	0 ~ 1000
4085	THD Voltage L1	word	0.1%	0 ~ 1000
4086	THD Voltage L2	word	0.1%	0 ~ 1000
4087	THD Voltage L3	word	0.1%	0 ~ 1000
4088	Energy Full Flag	word		*Energy flag bit 7 to 5 = reserved bit 4 = (-)kVARh bit 3 = (-) kWh bit 2 = kVAh bit 1 = (+)kVARh bit 0 = (+)kWh
4089	Power Factor L1	word	0.001	0 ~ 1.000
4090	Sign Power Factor L1	word	-	0=Resistive; 1=ind; 2=cap
4091	Power Factor L2	word	0.001	0 ~ 1.000
4092	Sign Power Factor L2	word	-	0=Resistive; 1=ind; 2=cap
4093	Power Factor L3	word	0.001	0 ~ 1.000
4094	Sign Power Factor L3	word	-	0=Resistive; 1=ind; 2=cap

\*if the energy is full, the bit is set to 1, else bit is 0.

Table 7: Operation data register (cont)

Read Only (Function 0x03 or 0x04)				
Register	Description	Type	Min. Unit	Range
4095	Sign Total Power Factor	word	-	0=Resistive; 1=ind; 2=cap
4096-4097	Current L1 Max.	dword	0.001A	0~999.9kA
4098-4099	Reserved			
4100-4101	Current L2 Max.	dword	0.001A	0~999.9kA
4102-4103	Reserved			
4104-4105	Current L3 Max.	dword	0.001A	0~999.9kA
4106-4107	Reserved			
4108-4109	Current Ln Max.	dword	0.001A	0~999.9kA
4110-4111	Reserved			
4112-4113	Voltage L1 Max.	dword	0.1V	0~999.9kV
4114-4115	Reserved			
4116-4117	Voltage L2 Max.	dword	0.1V	0~999.9kV
4118-4119	Reserved			



Table 7: Operation data register (cont)

Read Only (Function 0x03 or 0x04)				
Register	Description	Type	Min. Unit	Range
4120-4121	Voltage L3 Max.	dword	0.1V	0~999.9kV
4122-4123	Reserved			
4124-4125	Voltage L12 Max.	dword	0.1V	0~999.9kV
4126-4127	Reserved			
4128-4129	Voltage L23 Max.	dword	0.1V	0~999.9kV
4130-4131	Reserved			
4132-4133	Voltage L31 Max.	dword	0.1V	0~999.9kV
4134-4135	Reserved			
4136-4137	Total Real Power Max.	int	1W	-2000M~2000M
4138-4139	Reserved			
4140-4141	Total Apparent Power Max.	dword	1VA	0~2000M
4142-4143	Reserved			
4144-4145	Total Reactive Power Max.	int	1VAR	-2000M~2000M

Table 7: Operation data register (cont)

Read Only (Function 0x03 or 0x04)				
Register	Description	Type	Min. Unit	Range
4146-4147	Reserved			
4148-4149	Max. Real Power L1	int	1W	-2000M~2000M
4150-4151	Reserved			
4152-4153	Max. Real Power L2	int	1W	-2000M~2000M
4154-4155	Reserved			
4156-4157	Max. Real Power L3	int	1W	-2000M~2000M
4158-4159	Reserved			
4160-4161	Max. Apparent Power L1	dword	1VA	0~2000M
4162-4163	Reserved			
4164-4165	Max. Apparent Power L2	dword	1VA	0~2000M
4166-4167	Reserved			
4168-4169	Max. Apparent Power L3	dword	1VA	0~2000M

Table 7: Operation data register (cont)

Read Only (Function 0x03 or 0x04)				
Register	Description	Type	Min. Unit	Range
4170-4171	Reserved			
4172-4173	Max. Reactive Power L1	int	1VAR	-2000M~2000M
4174-4175	Reserved			
4176-4177	Max. Reactive Power L2	int	1VAR	-2000M~2000M
4178-4179	Reserved			
4180-4181	Max. Reactive Power L3	int	1VAR	-2000M~2000M
4182-4183	Reserved			
4184-4185	Current L1 Min.	dword	0.001A	0~999.9kA
4186-4187	Reserved			
4188-4189	Current L2 Min.	dword	0.001A	0~999.9kA
4190-4191	Reserved			
4192-4193	Current L3 Min.	dword	0.001A	0~999.9kA
4194-4195	Reserved			

Table 7: Operation data register (cont)

Read Only (Function 0x03 or 0x04)				
Register	Description	Type	Min. Unit	Range
4196-4197	Current Ln Min.	dword	0.001A	0~999.9kV
4198-4199	Reserved			
4200-4201	Voltage L1 Min.	dword	0.1V	0~999.9kV
4202-4203	Reserved			
4204-4205	Voltage L2 Min.	dword	0.1V	0~999.9kV
4206-4207	Reserved			
4208-4209	Voltage L3 Min.	dword	0.1V	0~999.9kV
4210-4211	Reserved			
4212-4213	Voltage L12 Min.	dword	0.1V	0~999.9kV
4214-4215	Reserved			
4216-4217	Voltage L23 Min.	dword	0.1V	0~999.9kV
4218-4219	Reserved			
4220-4221	Voltage L31 Min.	dword	0.1V	0~999.9kV

Table 7: Operation data register (cont)

Read Only (Function 0x03 or 0x04)				
Register	Description	Type	Min. Unit	Range
4222-4223	Reserved			
4224-4225	Total Real Power Min.	int	1W	-2000M~2000M
4226-4227	Reserved			
4228-4229	Total Apparent Power Min.	dword	1VA	0~2000M
4230-4231	Reserved			
4232-4233	Total Reactive Power Min.	int	1VAR	-2000M~2000M
4234-4235	Reserved			
4236-4237	Real Power Min. L1	int	1W	-2000M~2000M
4238-4239	Reserved			
4240-4241	Real Power Min. L2	int	1W	-2000M~2000M
4242-4243	Reserved			
4244-4245	Real Power Min. L3	int	1W	-2000M~2000M
4246-4247	Reserved			

Table 7: Operation data register (cont)

Read Only (Function 0x03 or 0x04)				
Register	Description	Type	Min. Unit	Range
4248-4249	Apparent Power Min. L1	dword	1VA	0~2000M
4250-4251	Reserved			
4252-4253	Apparent Power Min. L2	dword	1VA	0~2000M
4254-4255	Reserved			
4256-4257	Apparent Power Min. L3	dword	1VA	0~2000M
4258-4259	Reserved			
4260-4261	Reactive Power Min. L1	int	1VAR	-2000M~2000M
4262-4263	Reserved			
4264-4265	Reactive Power Min. L2	int	1VAR	-2000M~2000M
4266-4267	Reserved			
4268-4269	Reactive Power Min. L3	int	1VAR	-2000M~2000M
4270-4271	Reserved			

Read or write (Function 0x03,0x04 or 0x06)		
Register	Description	Range
100	PT ratio primary	100~33kV
101	PT ratio secondary	100~250V
102	CT ratio primary	5~9995A
103	CT ratio secondary	5A
104	Interval Demand	60~1800s
105	Sub-Interval Demand	1~120
106	System Configuration	3P4W/ 3P3W
107	Backlight setting	ON/OFF
108	System scroll setting	ON/OFF
109	Scroll interval	1-10 secs
110	Neutral setting	ON/OFF
111	Minutes	0-59mins
112	Hours	0-23hrs
113	Days	0-9999day

Table 8: Setting data register

**NOTE:**

Register list is based on firmware version 1.0

## ***9. Maintenance and Troubleshooting***

The power meter does not contain any user-serviceable parts. If the power meter requires service, please contact your local sales representative. Do not open the power meter. Opening the power meter voids the warranty.

**NOTE:**

We reserve the right to alter or modify the information contained herein at any time in line with our product development without prior notification. We also reserve the right to discontinue production & delivery of product.



# 10. Meter Dimension

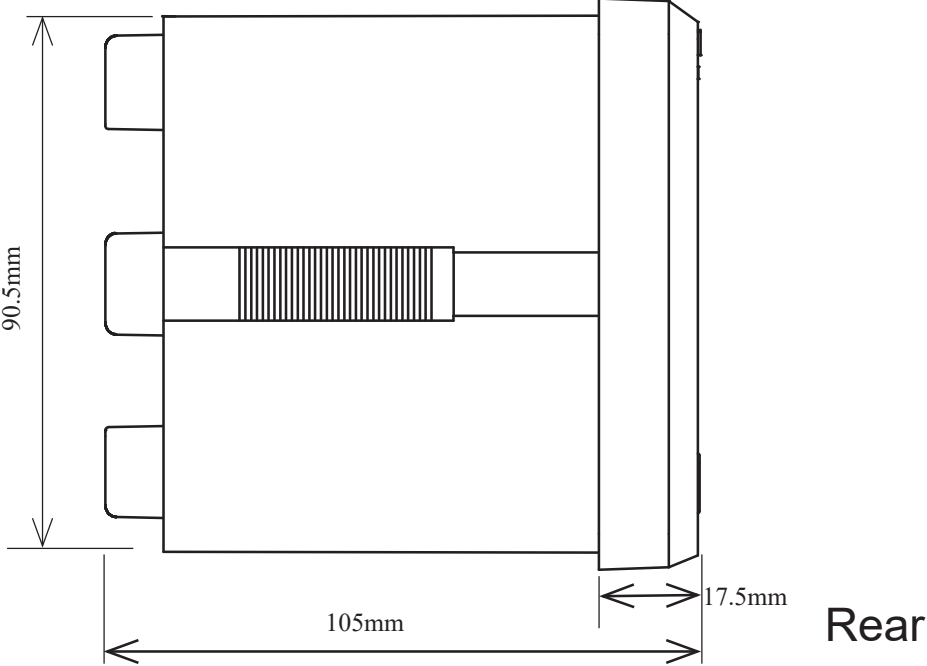
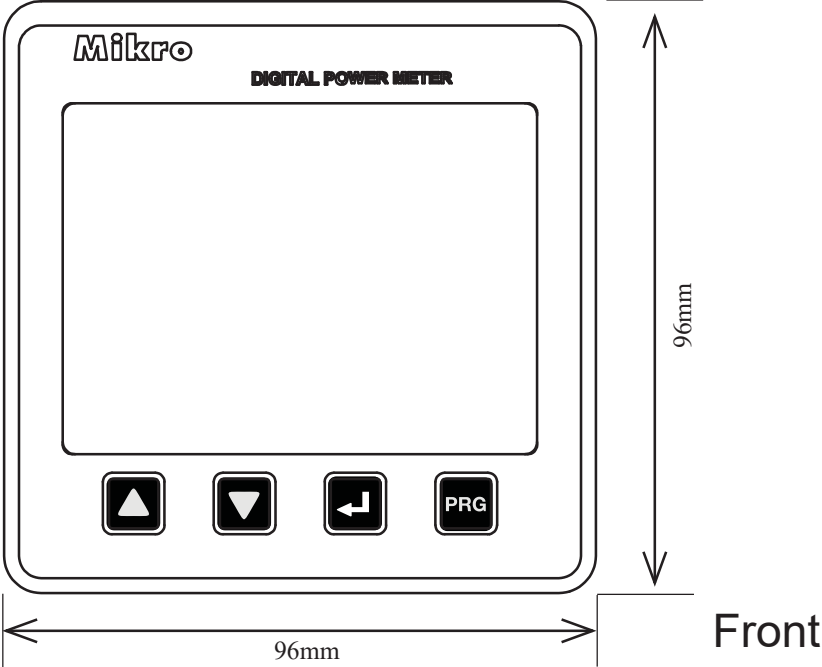

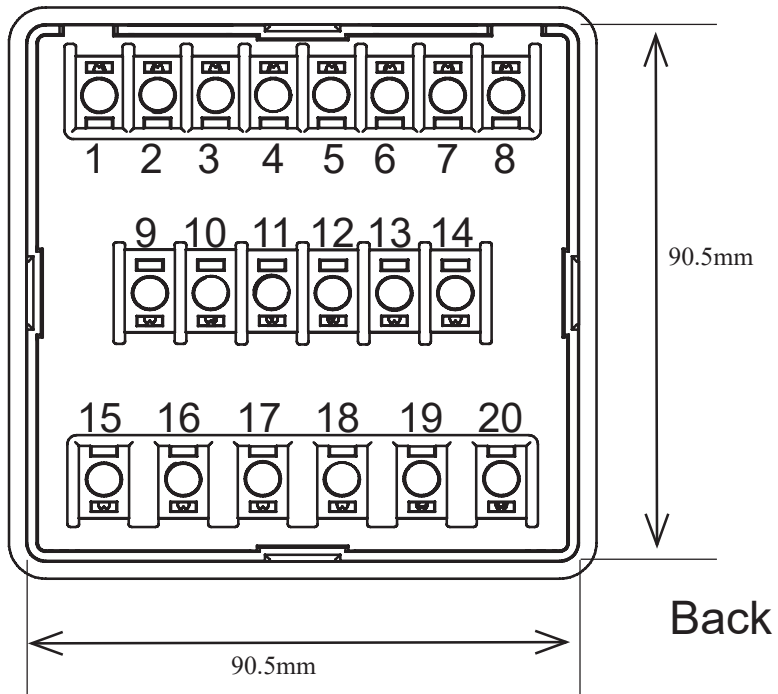

# 11. Appendix

## 11.1. DEMAND CALCULATION

Demand parameters are used to show average values over a demand interval. This power meter uses sliding block method. The demand value is based on interval divided by sub-interval time. Example is shown below:

SETTING: Interval time = 180 seconds ; sub-interval = 3

Measurement = interval time / sub-interval = 180 / 3 = 60 seconds

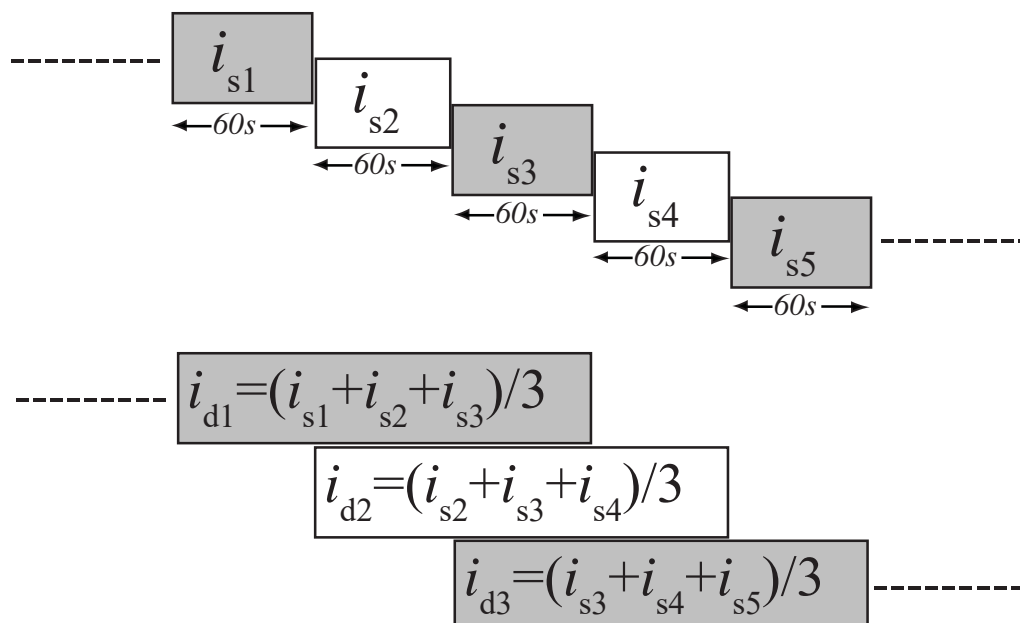

## 11.2. DATA READ FORMAT FROM MODBUS

a) **4000-4001** : Negative Real Energy

Address 4000		Address 4001	
MSB	LSB	MSB	LSB
0x00	0x01	0x23	0x34

Negative Real Energy = 0x00012334  
 =74548 x 1kWh (min value)  
 =74548kWh

b) **4012-4013** : Total Real Power; (Signed register)

Address 4012		Address 4013	
MSB	LSB	MSB	LSB
0xFF	0xFB	0x6C	0x20

Total Real Power = 0xFFFB6C20  
 If MSB is “1”, it is negative value;  
 Total Real Power = 0xFFFB6C20 x (-1);  
 = 0x493E0; 300 000  
 = 300000 x 1W(min value)  
 = -300kW