



NX1000A

Features

- Microprocessor based numerical relay
- Current measurement based on fundamental frequency
- Three-phase, low-set overcurrent
- Three-phase, high-set overcurrent
- Low-set earth-fault
- High-set earth-fault
- Definite time for low-set and high-set
- Five selectable IDMT characteristic curves
- Local display of measured and set values
- Programmable relay outputs
- Non-volatile fault values recording
- Complies with IEC 60255 standard
- ANSI Code : 50P, 50G, 51P, 51G

Technical Data

RATINGS

Rated current (I_n)	: 5 A
Rated frequency	: 50 or 60 Hz
Burden	: < 0.3 VA at I_n
Thermal withstand	: 4 x I_n continuous

AUXILIARY SUPPLY

Model NX1000A-240A(6)	: 198 ~ 265 V AC
Model NX1000A-240AD(6)	: 85 ~ 265 V AC 110 VDC ~ 340 VDC
Model MK1000A-150D(6)	: 24 ~ 150 V DC
Supply frequency	: 50 or 60 Hz
V A rating	: 3 VA typical

ACCURACY

Protection thresholds	: $\pm 5\%$
Time delay	: $\pm 5\%$ with a minimum of 50 ms

OUTPUT CONTACTS

Trip Contacts (R1 & R2)	
Rated voltage	: 250V AC / DC
Contact rating	: 5 A
Expected electrical life	: 100,000 operations at rated current
Expected mechanical life	: 5 x 10 ⁶ operations

SETTING RANGES

I) OVERCURRENT ELEMENTS

Low-set (I >)	: 0.5 A to 10.0 A, step 0.05 A
	: 10% to 200%, step 1%
Low-set time multiplier (kt >)	: 0.05 to 1.0, step 0.01
Low-set definite time (t >)	: 0.05 to 99s
High-set (I >>)	: 0.5 A to 99.9 A, step 0.10 A or disable
	: 10% to 1998%, step 2%
High-set delay time (t >>)	: 0.05 sec to 2.5 sec, step 0.01

II) EARTH-FAULT ELEMENT

Low-set (I _o >)	: 0.10 A to 5.0 A, step 0.05 A
	: 2% to 100%
Low-set time multiplier(kt _o >)	: 0.05 to 1.0, step 0.01
Low-set definite time (t _o >)	: 0.05 to 99s
High-set (I _o >>)	: 0.10 A to 50 A, step 0.10 A or disable
	: 2% to 1000%, step 2%
High-set delay time (t _o >>)	: 0.05 sec to 2.5 sec, step 0.01

INDICATORS

Auxiliary supply	: Green indicator
Pick-up	: Red indicator
Trip	: 7-segment display and Red indicators

ENVIRONMENTAL CONDITIONS

Temperature	: -5°C to +55°C
Humidity	: 56 days at 93% RH and 40°C non-condensing

MECHANICAL

Mounting	: Panel mounting
Dimension (mm)	: 96(w) x 96(h) x 110(d)
Enclosure protection:	IP54 at the panel
Approximate weight	: 0.8 kg

Normal Inverse

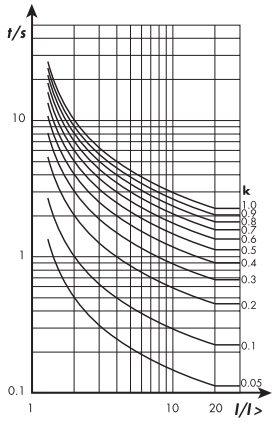

Very Inverse

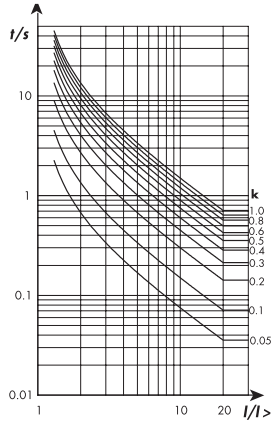

Long Time Inverse

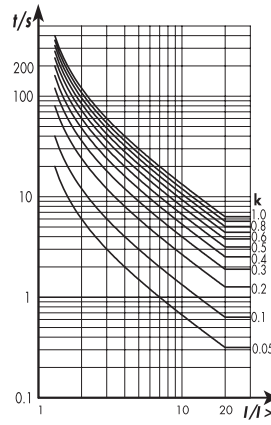

Extremely Inverse

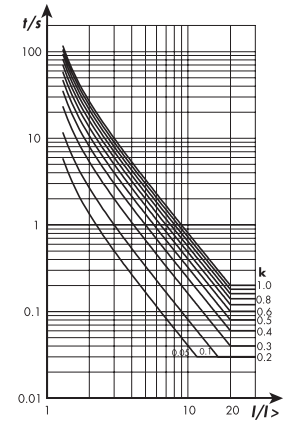

Normal Inverse 1.3/10

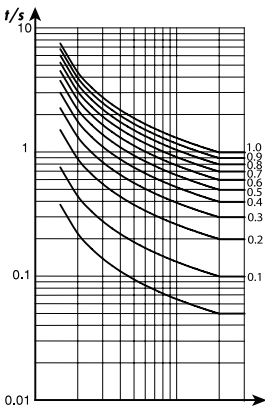

Typical Application Diagram

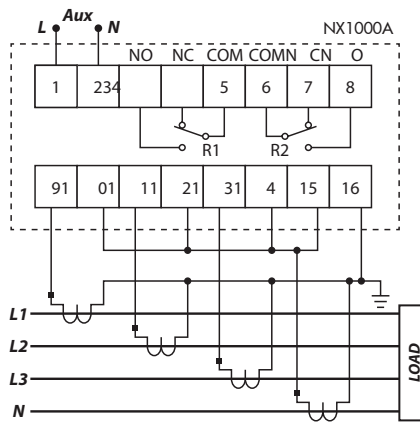

Case Dimensions

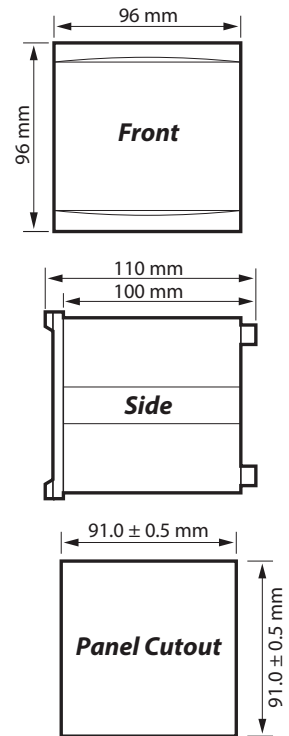

Ordering Information

MODEL	DESCRIPTION
NX1000A-240A	For 50Hz system, auxiliary voltage 198 ~ 265 V AC
NX1000A-240AD	For 50Hz system, auxiliary voltage 85 ~ 265 V AC or 110~340 V DC
NX1000A-150D	For 50Hz system, auxiliary voltage 24 ~ 150 V DC
NX1000A-240AD6	For 60Hz system, auxiliary voltage 85 ~ 265 V AC or 110~340 V DC
NX1000A-150D6	For 60Hz system, auxiliary voltage 24 ~ 150 V DC