

NX232A Earth-fault Relay User's Guide

A BRIEF OVERVIEW

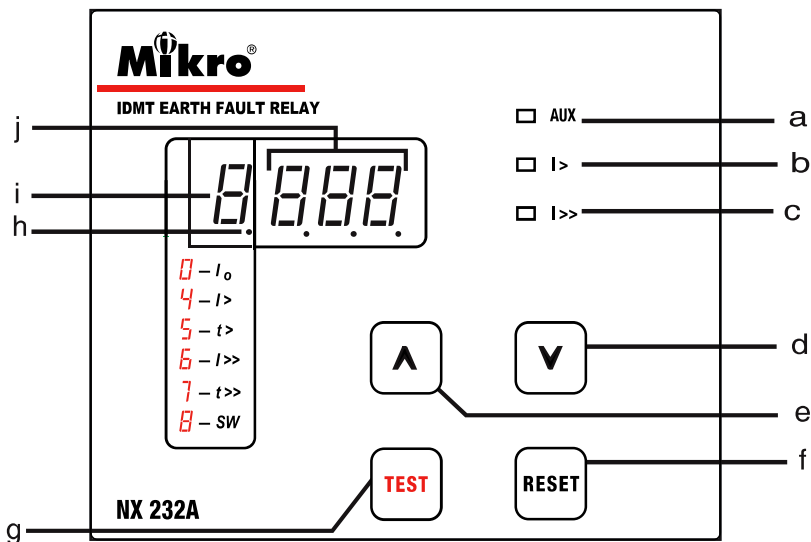

- a - Auxiliary power supply indicator
- b - Low-set start/trip status indicator
- c - High-set start/trip status indicator
- d - Down key
- e - Up key
- f - Reset key
- g - Test key
- h - DP indicator
- i - FUNCTION indicator
- j - DATA indicator

Symbols

- I_0 - Earth-fault current
- $I>$ - Low-set
- $kt>$ - Low-set time multiplier
- $I>>$ - High-set
- $t>>$ - High-set delay time
- SW - Soft switches

1. DESCRIPTION

The NX232A is microprocessor based numerical earth-fault relay. It uses fundamental frequency current measurement for excellent harmonic current rejection. The relay consists of independent low-set and high-set elements. The high-set element can be disabled by the user. The time current characteristics of the low set element are definite time or five selectable IDMT curves. The high-set element is a definite time or instantaneous relay. The 4-digit panel display on the NX232A allows the display of the present load current; recorded fault current for last tripping; and all settings of the relay.

2. LIGHT INDICATORS

The indicators display the status of the system as follow:

Indicator					Status
Aux	I>	I>>	FUNC	DT	
0	0	0	0	0	No Auxiliary power supply.
1	0	0	X	X	Normal condition, no tripping.
1	1	0	X	X	Low-set overcurrent triggered, time delay countdown started.
1	0	1	X	X	High-set overcurrent triggered, time delay countdown started.
1	B	0	B	B	Low-set tripped, DT LEDs show tripped value.
1	0	B	B	B	High-set tripped, DT LEDs show tripped value.
1	X	X	B	1	Programming mode.

Table 1: System Status

1 = ON 0 = OFF X= don't care, not blinking
B = blinking DT = DATA FUNC = FUNCTION

Indicator		
FUNCTION	DP	DATA
0	off	Earth fault current.
0	blink	Previous tripped current.
4	off	Low-set current setting.
5	off	Time multiplier/delay time setting.
6	off	High-set current setting.
7	off	High-set delay time setting.
8	off	Soft switch setting.

Table 2: FUNCTION Code

Note: Under normal operating condition, The 4-digit display is off. When the RESET key is pressed, the 4-digit display will light up. The display will switch off automatically after 6 minutes if no further key is pressed.

3. PUSH-BUTTONS OPERATION

a) Trip test

Press and hold the "TEST" button for 3 seconds to stimulate a trip.

Display shows "TEST", indicators I> and I>> turn "ON" when "TEST" button is pressed.

b) Trip reset

Press the "RESET" button to reset the relay when tripped.

c) View setting

When the relay is not under tripped condition, pressing the "RESET" button will scroll through the various functions.

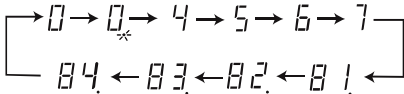

Figure 1: Scroll sequence

d) Program setting

Only function codes from 4 to 8 can be programmed.

Step 1: Press RESET key until the function digit shows required function.

Step 2: Press the UP and DOWN key simultaneously to enter programming mode. The function digit will blink to indicate the relay is in programming

Step 3: Use the UP or DOWN key to select the desired value.

Step 4: To save the selected value, press the UP and DOWN key simultaneously again. It will exit the programming mode with the data digits displaying new setting.

To exit programming mode without saving the selected setting, press the RESET key once.

4. OUTPUT CONTACTS

The NX232A has two set of output contact:

- (i) CONTACT R1 - linked to trip signal.
- (ii) CONTACT R2 - linked to trip or start signal.

The output contact can be programmed to be either auto reset type or manual reset type.

For auto reset type, the contact remain activated until the fault current is removed.

For manual reset type, the contact remain activated.

5. SOFT SWITCHES

The NX232A incorporates 4 soft switches for system configuration. When the function digit shows "8", the relay is in soft switch setting mode.

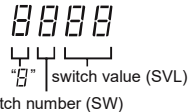

SW	SVL	System configuration
1	00	Contact R1 linked to trip signal auto reset type.
	01	Contact R1 linked to trip signal manual reset type.
2	00	Contact R2 linked to trip signal auto reset type.
	01	Contact R2 linked to trip signal manual reset type.
	10	Contact R2 linked to signal auto reset type.
	11	Contact R2 linked to signal manual reset type.
3	00	Low-set normal inverse curve 3/10.
	01	Low-set normal inverse curve 1.3/10.
	02	Low-set long time inverse curve.
	03	Low-set very inverse curve.
	04	Low-set extremely inverse curve.
	05	Low-set definite time.
4	00	High-set disabled.
	01	High-set enabled.

Table 3: Soft switch setting

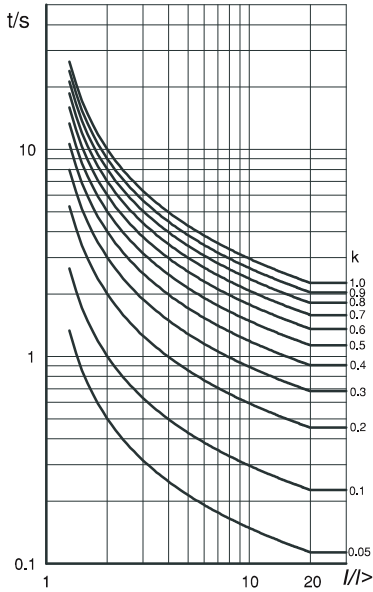

Figure 2: IDMT Normal Inverse Curve 3/10

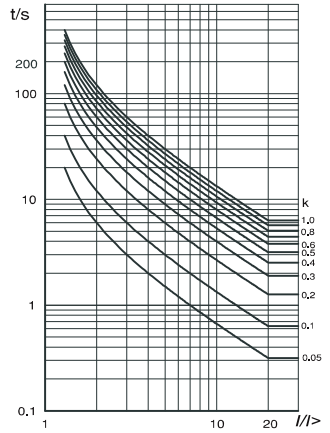

Figure 4: IDMT Long time Inverse Curve

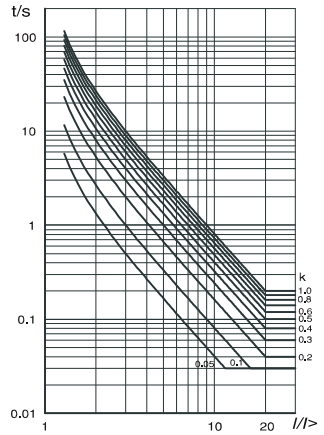

Figure 6: IDMT Extremely Inverse Curve

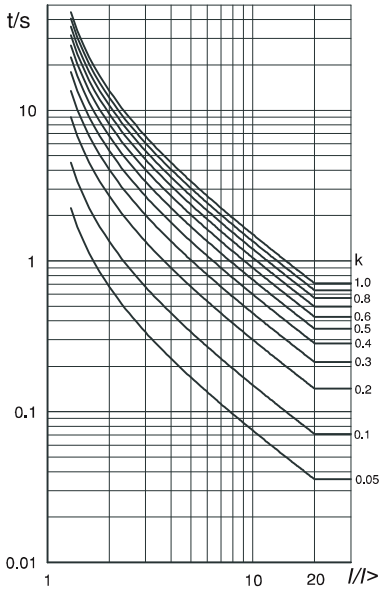

Figure 5: IDMT Very Inverse Curve

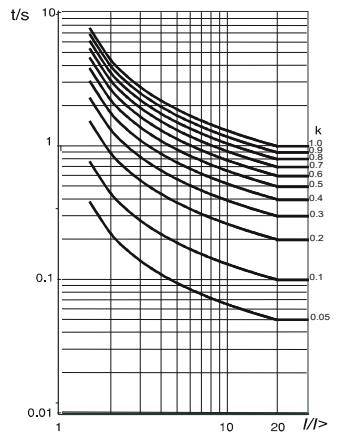

Figure 5: IDMT Normal Inverse Curve 1.3/10

6. TECHNICAL DATA

Ratings

Rated current I_n 5 A
 Frequency50 Hz or 60 Hz
 Burden< 0.3 VA at I_n

Auxiliary Supply

NX232A-240A(6)198~265 VAC
 NX232A-240AD(6)85~265 VAC/110~370VDC
 NX232A-110A(6).....94~127 VAC
 Supply frequency50 Hz or 60 Hz
 VA rating3 VA typical

Setting Ranges

Low-set setting $I >$ 0.10 - 5.00 A (2%-100%)
 Time multiplier $kt >$ 0.05- 1.00
 Low-set definite time $t >$ 0.05- 99 sec
 High-set setting $I >>$ 0.10 - 50.0 A (2%-1000%)
 High-set definite time $t >>$ 0.05 - 2.5sec

Outputs

Trip Contact:
 Rated voltage250 VAC
 Continuous carry5A ($\cos \Phi = 1.0$)
 Make and carry for 0.2 s30A

Contact specification

Expected electrical life 10^5 operations
 Expected mechanical life 5×10^6 operations

Indicators

Auxiliary supplyGreen LED indicator
 Pick upRed LED indicator
 Trip7 segment LED and red LED indicators

Mechanical

MountingPanel mounting
 Front panelStandard DIN 96x96 mm
 Approximate weight0.6 kg

7. CONNECTION DIAGRAMS

a) Earth Fault Relay

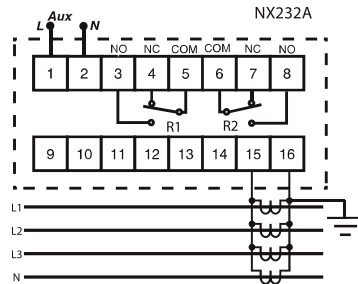

b) Overcurrent Relay and Earth fault relay (3 phase 4 wire system)

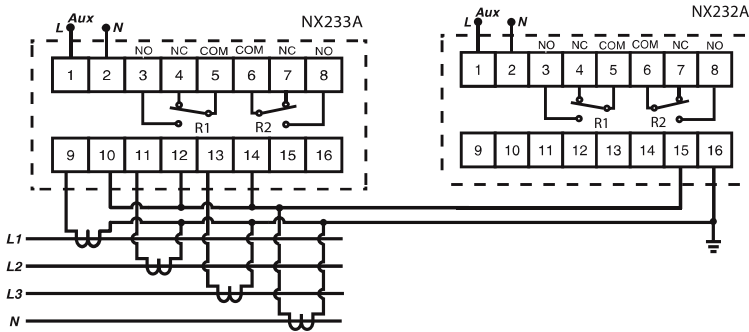

8. CASE DIMENSION

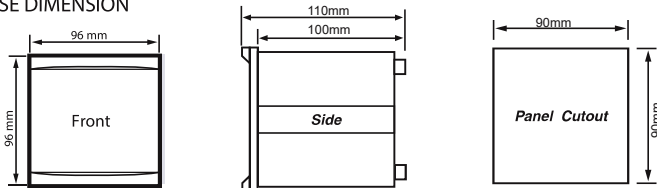

Figure 7: Case Dimension